

**Celosias Lamas fijas / Aluminio**  
*Volets jalousies Lames fixes / Aluminium*  
Louvers Fixed Blades / Aluminium

ALUMINIO | ALUMINIUM | ALUMINIUM  
 lamas fijas | lames fixes | fixed blades

Serie Z Z60

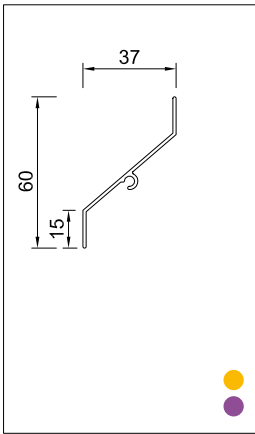

Serie Z Z80

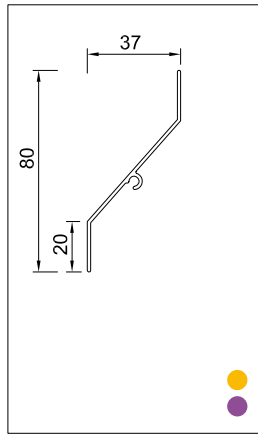

Serie Z Z120

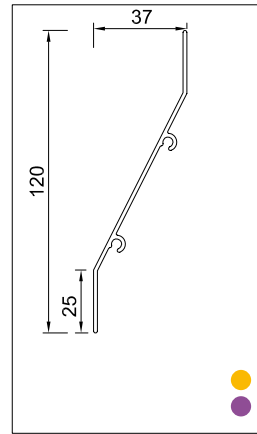

Alba Disseny OP100

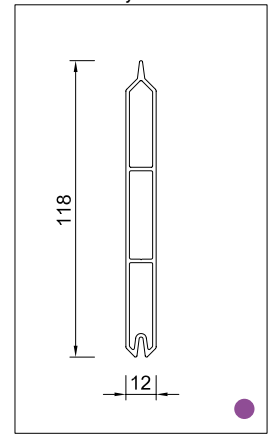

Alba Disseny VL100

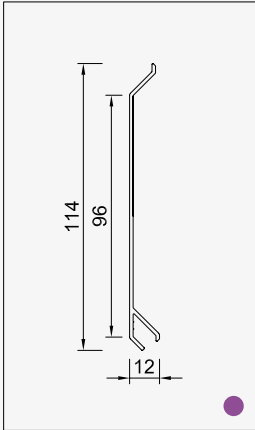

Alba Disseny VL100P

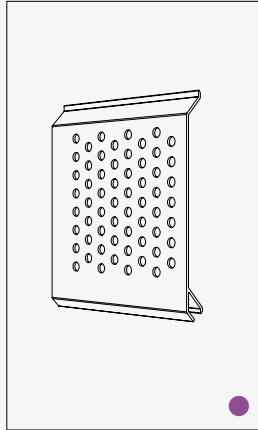

Alba Disseny C140

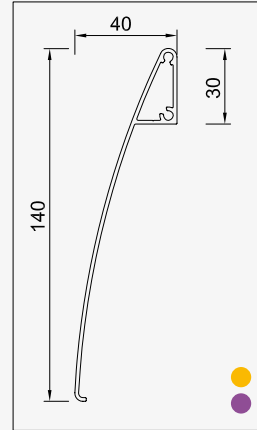

Alba Disseny C140P

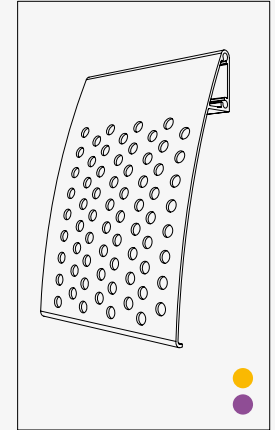

Alba Disseny A53.14

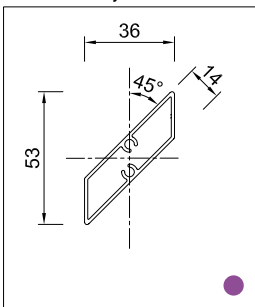

Alba Disseny A57.14

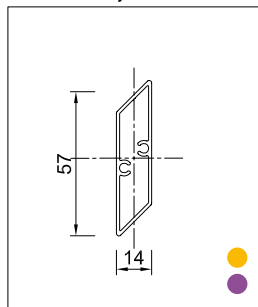

Alba Disseny A90.9

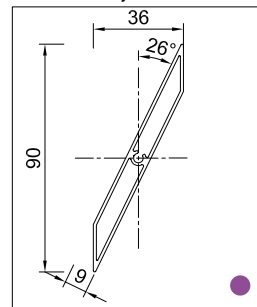

Alba Disseny A97.9

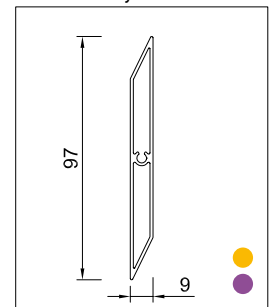

Alba Disseny ALT70.0

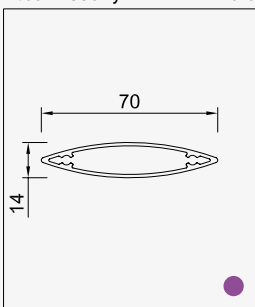

Alba Disseny ALT70.45

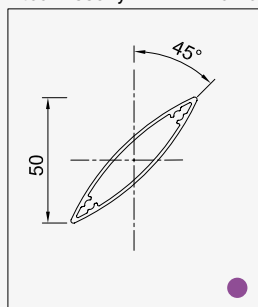

Alba Disseny ALT70.30

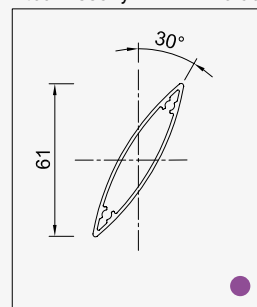

Alba Disseny A95.37

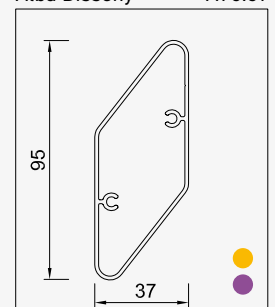

● lama continua | lame filante | continuous blade  
 (bastidor oculto | cadre caché | hidden frame)

● lama enmarcada | lame encastrée | framed blade

ALUMINIO | ALUMINIUM | ALUMINIUM  
 lamas fijas | lames fixes | fixed blades

Alba Disseny A36.12H

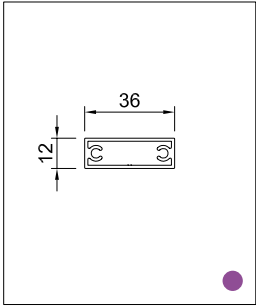

Alba Disseny A36.12V

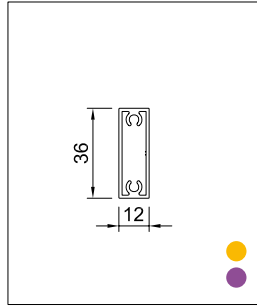

Alba Disseny A36.12.35

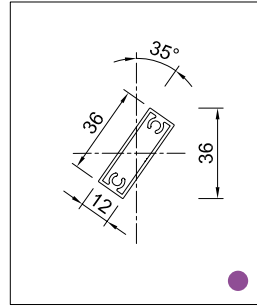

Alba Disseny A36.12.45

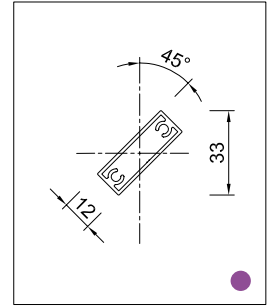

Alba Disseny RD38

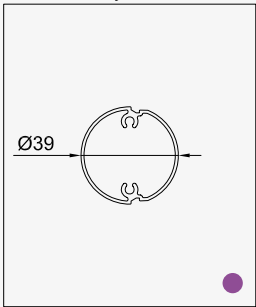

Alba Disseny A37.20H

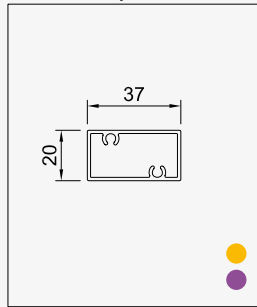

Alba Disseny A37.20V

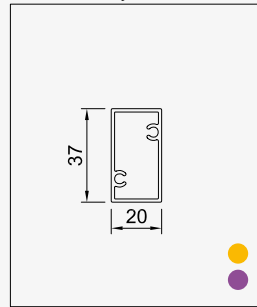

Alba Disseny A37.36

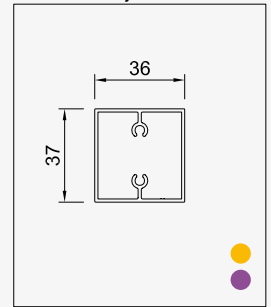

Alba Disseny A60.20H

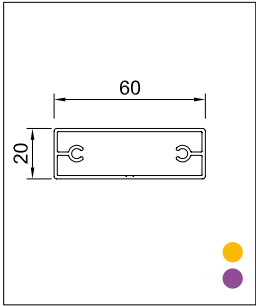

Alba Disseny A60.20V

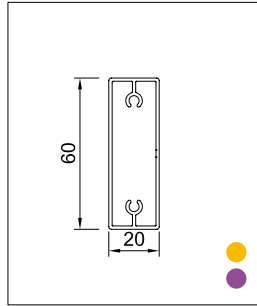

Alba Disseny A80.20H

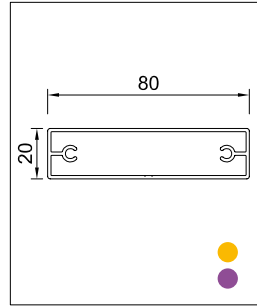

Alba Disseny A80.20V

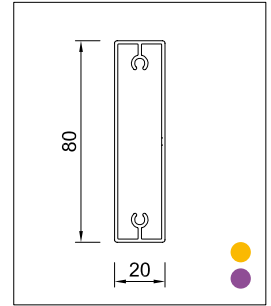

Alba Clasic A35.8

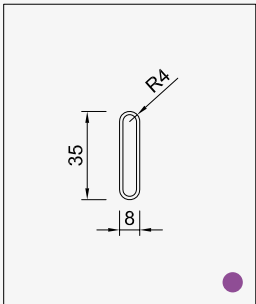

Alba Clasic A35.8.30

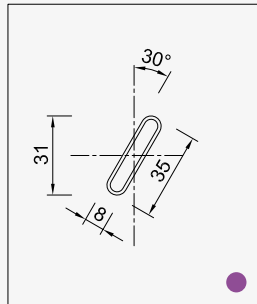

Alba Clasic A50.10

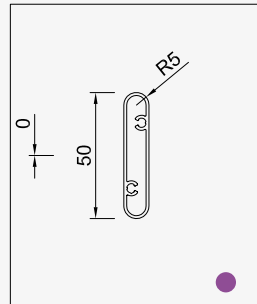

Alba Clasic A50.10.35

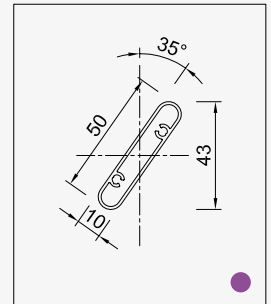

# ALUMINIO | ALUMINIUM | ALUMINIUM

## laminas fijas enmarcadas | lames fixes encastrées | framed fixed blades modelos | modèles | models

bastidor cadre frame	lama lame blade	modelos modèles models	E	soluciones constructivas solutions constructives constructive solutions	ancho máximo largeur max width max (mm)*	L (estándar) L (standard) L (standard)	opciones   options   options	
							paso variable pas variable variable pitch	solape chevauchement overlap
40N.H	Z60	Z60/40N.H	40mm	■	1000	0	↕	✓
	Z80	Z80/40N.H		■	1100	0	↕	✓
	Z120	Z120/40N.H		■	1200	0	↕	✓
60N.H	Z60	Z60/60N.H	40mm	■	1000	0	↕	✓
	Z80	Z80/60N.H		■	1100	0	↕	✓
	Z120	Z120/60N.H		■	1200	0	↕	✓
40SC.H	Z60	Z60/40SC.H	40mm	●	1000	0	↕	✓
	Z80	Z80/40SC.H		●	1100	0	↕	✓
	Z120	Z120/40SC.H		●	1200	0	↕	✓
60SC.H	Z60	Z60/60SC.H	40mm	●	1000	0	↕	✓
	Z80	Z80/60SC.H		●	1100	0	↕	✓
	Z120	Z120/60SC.H		●	1200	0	↕	✓
60AB	VL100	VL100/60AB	40mm	●	1000	0		
	OP100	OP100/60AB		●	1200	0		
	VL100P	VL100P/60AB		●	1000	0		
60AT	A53.14	A53.14/60AT	40mm	●	1500	10	↕	✓
	A57.14	A57.14/60AT		●	1500	5	↕	✓
	A90.9	A90.9/60AT		●	1500	20	↕	
	A97.9	A97.9/60AT		●	1500	10	↕	
	ALT70.30	ALT70.30/60AT		●	2000	5	↕	✓
	A95.37	A95.37/60AT		●	1500	25	↕	✓
	A36.12H	A36.12H/60AT		●	1500	25	↕	
	A36.12V	A36.12V/60AT		●	1500	15	↕	
	A36.12.35	A36.12.35/60AT		●	1500	5	↕	✓
	A36.12.45	A36.12.45/60AT		●	1500	10	↕	✓
	RD38	RD38/60AT		●	1500	30	↕	
	A37.20H	A37.20H/60AT		●	1500	30	↕	
	A37.20V	A37.20V/60AT		●	1500	20	↕	
	A37.36	A37.36/60AT		●	1500	35	↕	
	A35.8	A35.8/60AT		●	1200	32	↕	
	A35.8.30	A35.8.30/60AT		●	1200	0	↕	✓
	A50.10	A50.10/60AT		●	1500	15	↕	
	A50.10.35	A50.10.35/60AT		●	1500	0	↕	✓
	A60.20V	A60.20V/60AT		●	1500	25	↕	
	A80.20V	A80.20V/60AT		●	1700	25	↕	

\* Ancho máximo sin travesaños vertical | \* largeur max sans montant central | \* maximum width without vertical transom

E= espesor bastidor | épaisseur de cadre | frame thickness

soluciones constructivas | solutions constructives | constructive solutions

■ marco fijo | cadre fixe | fixed frame

▲ fijo y corredera | fixe & coulissant | fixe & sliding

● todas | tous | all

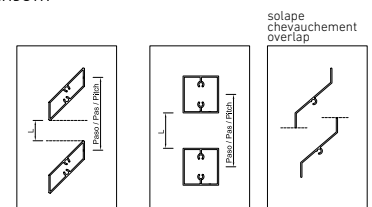

solape  
chevauchement  
overlap

# ALUMINIO | ALUMINIUM | ALUMINIUM

laminas fijas enmarcadas | lames fixes encastrées | framed fixed blades

modelos | modèles | models

bastidor cadre frame	lama lame blade	modelos modèles models	E	soluciones constructivas solutions constructives constructive solutions	ancho máximo largeur max width max (mm)*	L (estándar) L (standard) L (standard)	opciones   options   options		
							paso variable pas variable variable pitch	solape chevauchement overlap	
L50	A36.12H	A36.12H/L50	50mm	▲	1500	25	↕		
	A37.20H	A37.20H/L50		▲	1500	30	↕		
	A37.36	A37.36/L50		▲	1500	35	↕		
50.20L	C140	C140/50.20L		▲	1500	0	↕	✓	
	C140P	C140P/50.20L		▲	1500	15	↕	✓	
60.50L	Z60	Z60/60.50L		▲	1000	0	↕	✓	
	Z80	Z80/60.50L		▲	1100	0	↕	✓	
	Z120	Z120/60.50L		▲	1200	0	↕	✓	
L60	A50.10	A50.10/L60		60mm	▲	1500	30	↕	
P60	ALT70.30	ALT70.30/P60			▲	1500	25	↕	✓
	ALT70.45	ALT70.45/P60	▲		1500	30	↕	✓	
	A60.20H	A60.20H/P60	▲		1500	40	↕		
80.20H	A80.20H	A80.20H/80.20H	80mm		▲	1700	60	↕	

\* Ancho máximo sin travesaños vertical | \* largeur max sans montant central | \* maximum width without vertical transom

A37.20H/60AT



RD38/60AT



A50.10H/L60



A50.10.35/60AT



E= espesor bastidor | épaisseur de cadre | frame thickness

soluciones constructivas | solutions constructives | constructive solutions

■ marco fijo | cadre fixe | fixed frame

▲ fijo y corredera | fixe & coulissant | fixe & sliding

● todas | tous | all

ALUMINIO | ALUMINIUM | ALUMINIUM

laminas fijas enmarcadas | lames fixes encastrées | framed fixed blades

modelos | modèles | models

A53.14/60AT



ALT70.45/P60



A80.20H/80.20H



A90.9/60AT



C140/50.20L



C140P/50.20L



VL100/60AB



Z60/60.50L





hotel | *hôtel* | hotel  
A50.10/L60  
GCA Arquitectes  
Barcelona

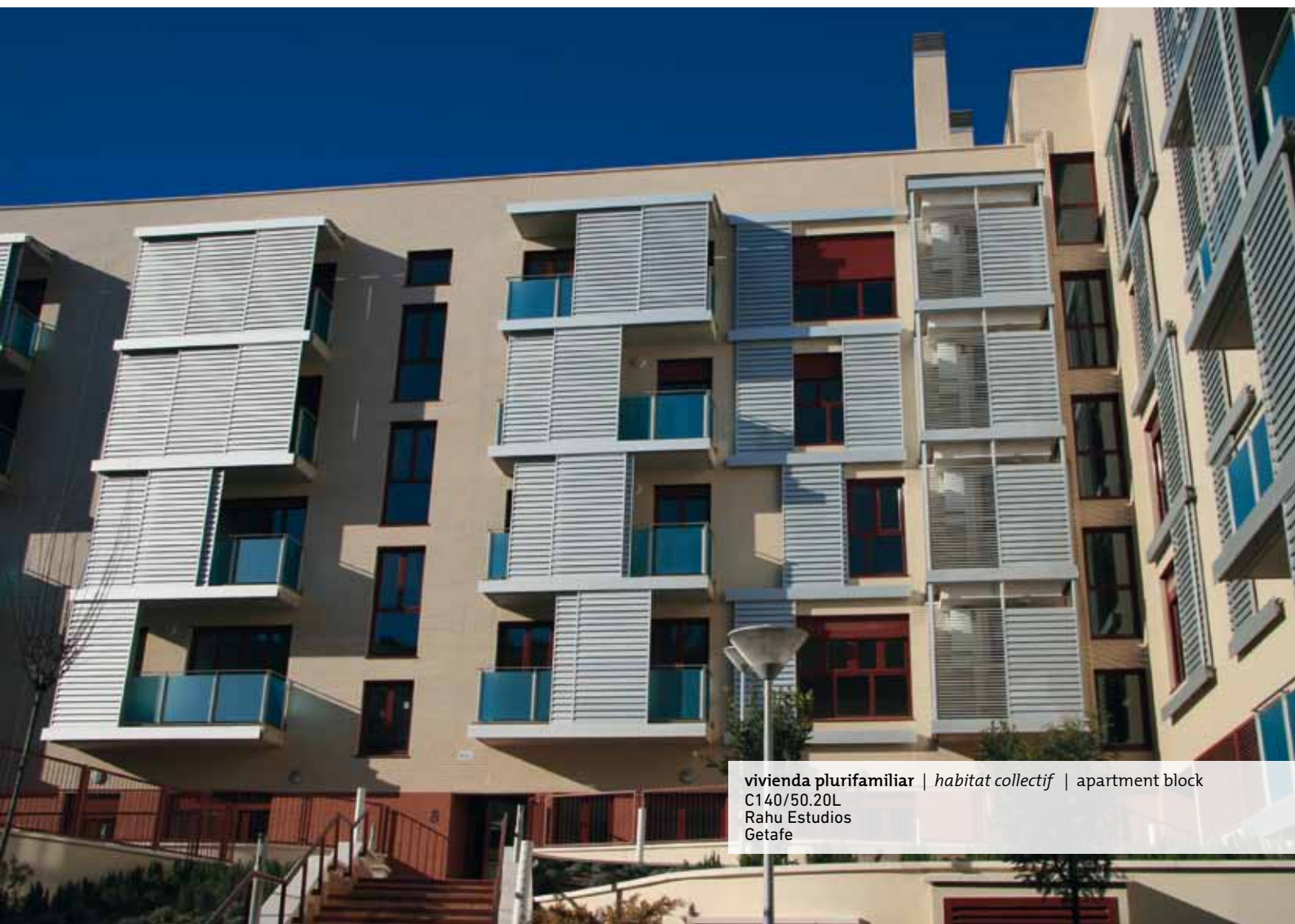

vivienda plurifamiliar | *habitat collectif* | apartment block  
C140/50.20L  
Rahu Estudios  
Getafe







parque de bomberos | caserne de pompiers | fire station  
A37.20H/40SC.P  
Alejandra Sainz & José Ramón Saiz Fouz Arquitectos  
Santander

# ALUMINIO | ALUMINIUM | ALUMINIUM

## laminas fijas continuas | lames fixes filantes | continuos fixed blades modelos | modèles | models

bastidor cadre frame	lama lame blade	modelos modèles models	E	soluciones constructivas solutions constructives constructive solutions	ancho máximo largeur max width max (mm)*	L (estándar) L (standard) L (standard)	opciones   options   options	
							paso variable pas variable variable pitch	solape chevauchement overlap
40N	Z60	Z60/40N	77mm	■	1000	0	↕	✓
	Z80	Z80/40N		■	1100	0	↕	✓
	Z120	Z120/40N		■	1200	0	↕	✓
60N	Z60	Z60/60N	77mm	■	1000	0	↕	✓
	Z80	Z80/60N		■	1100	0	↕	✓
	Z120	Z120/60N		■	1200	0	↕	✓
40SC	Z60	Z60/40SC	77mm	▲	1000	0	↕	✓
	Z80	Z80/40SC		▲	1100	0	↕	✓
	Z120	Z120/40SC		▲	1200	0	↕	✓
40SC.P	C140	C140/40SC.P	87mm	▲	1500	0	↕	✓
	A57.14	A57.14/40SC.P	61mm	▲	1500	5	↕	✓
	A97.9	A97.9/40SC.P	56mm	▲	1500	20	↕	✓
	A95.37	A95.37/40SC.P	84mm	▲	2000	25	↕	✓
	A36.12V	A36.12V/40SC.P	59mm	▲	1500	15	↕	
	A37.20H	A37.20H/40SC.P	84mm	▲	1500	30	↕	
	A37.20V	A37.20V/40SC.P	67mm	▲	1500	20	↕	
	A37.36	A37.36/40SC.P	83mm	▲	1500	35	↕	
	A60.20H	A60.20H/40SC.P	107mm	▲	1500	40	↕	
	A60.20V	A60.20V/40SC.P	67mm	▲	1500	25	↕	
	A80.20H	A80.20H/40SC.P	127mm	▲	1500	60	↕	
	A80.20V	A80.20V/40SC.P	67mm	▲	1700	25	↕	
60SC	Z60	Z60/60SC	77mm	▲	1000	20	↕	✓
	Z80	Z80/60SC		▲	1100	20	↕	✓
	Z120	Z120/60SC		▲	1200	0	↕	✓
60SC.P	C140	C140/60SC.P	87mm	▲	1500	5	↕	✓
	A57.14	A57.14/60SC.P	61mm	▲	1500	20	↕	✓
	A97.9	A97.9/60SC.P	56mm	▲	1500	25	↕	✓
	A95.37	A95.37/60SC.P	84mm	▲	2000	15	↕	✓
	A36.12V	A36.12V/60SC.P	59mm	▲	1500	30	↕	
	A37.20H	A37.20H/60SC.P	84mm	▲	1500	20	↕	
	A37.20V	A37.20V/60SC.P	67mm	▲	1500	35	↕	
	A37.36	A37.36/60SC.P	83mm	▲	1500	40	↕	
	A60.20H	A60.20H/60SC.P	107mm	▲	1500	25	↕	
	A60.20V	A60.20V/60SC.P	67mm	▲	1500	60	↕	
	A80.20H	A80.20H/60SC.P	127mm	▲	1500	25	↕	
	A80.20V	A80.20V/60SC.P	67mm	▲	1700	20	↕	

\* Ancho máximo sin travesaños vertical | \* largeur max sans montant central | \* maximum width without vertical transom

E= espesor bastidor | épaisseur de cadre | frame thickness  
soluciones constructivas | solutions constructives | constructive solutions

■ marco fijo | cadre fixe | fixed frame

▲ fijo y corredera | fixe & coulissant | fixe & sliding

● todas | tous | all

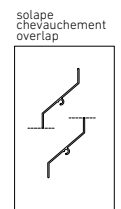
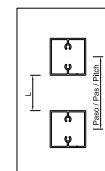
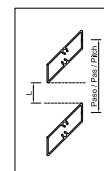

ALUMINIO | ALUMINIUM | ALUMINIUM

laminas fijas continuas | lames fixes filantes | continuos fixed blades

modelos | modèles | models

Z80/40SC



Pletina F0C

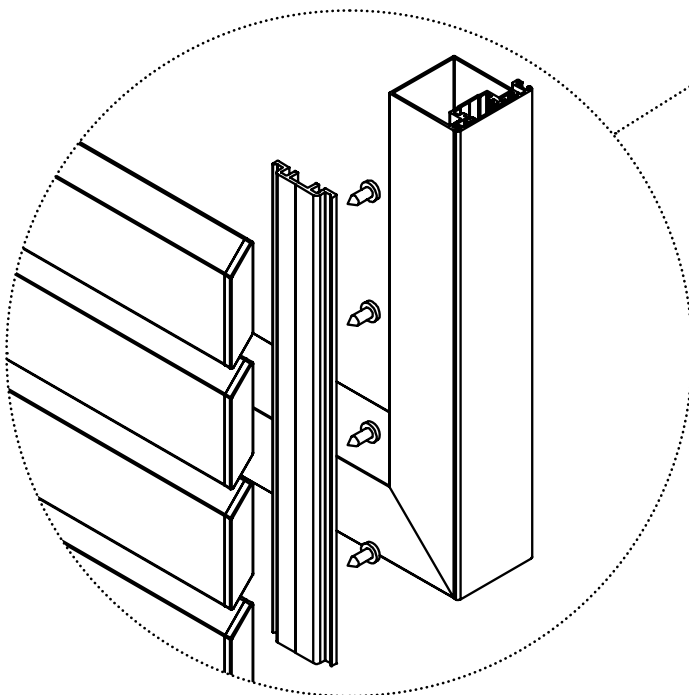
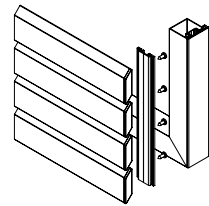
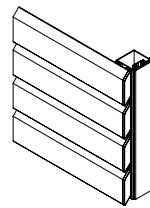
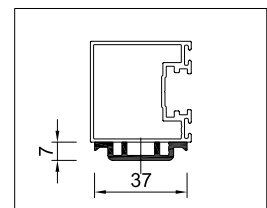
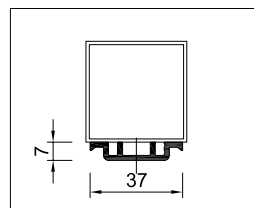
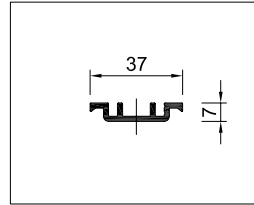

detalle montaje lama continua  
détail du montage lame filante  
assembly detail continuos blade

ALUMINIO | ALUMINIUM | ALUMINIUM

laminas fijas continuas | lames fixes filantes | continuos fixed blades

modelos | modèles | models

A37.36/40SCP



Z60/40SC



A60.20H/40SCP



A62.14/40SCP

