

Tamifix

tamifix

aluminio | *aluminium* | aluminium

partesol continuo | *protection solaire filante* | continuous louver





vivienda plurifamiliar | *habitat collectif* | apartment block
PT70
Arquiwork Arquitectes
Tarragona

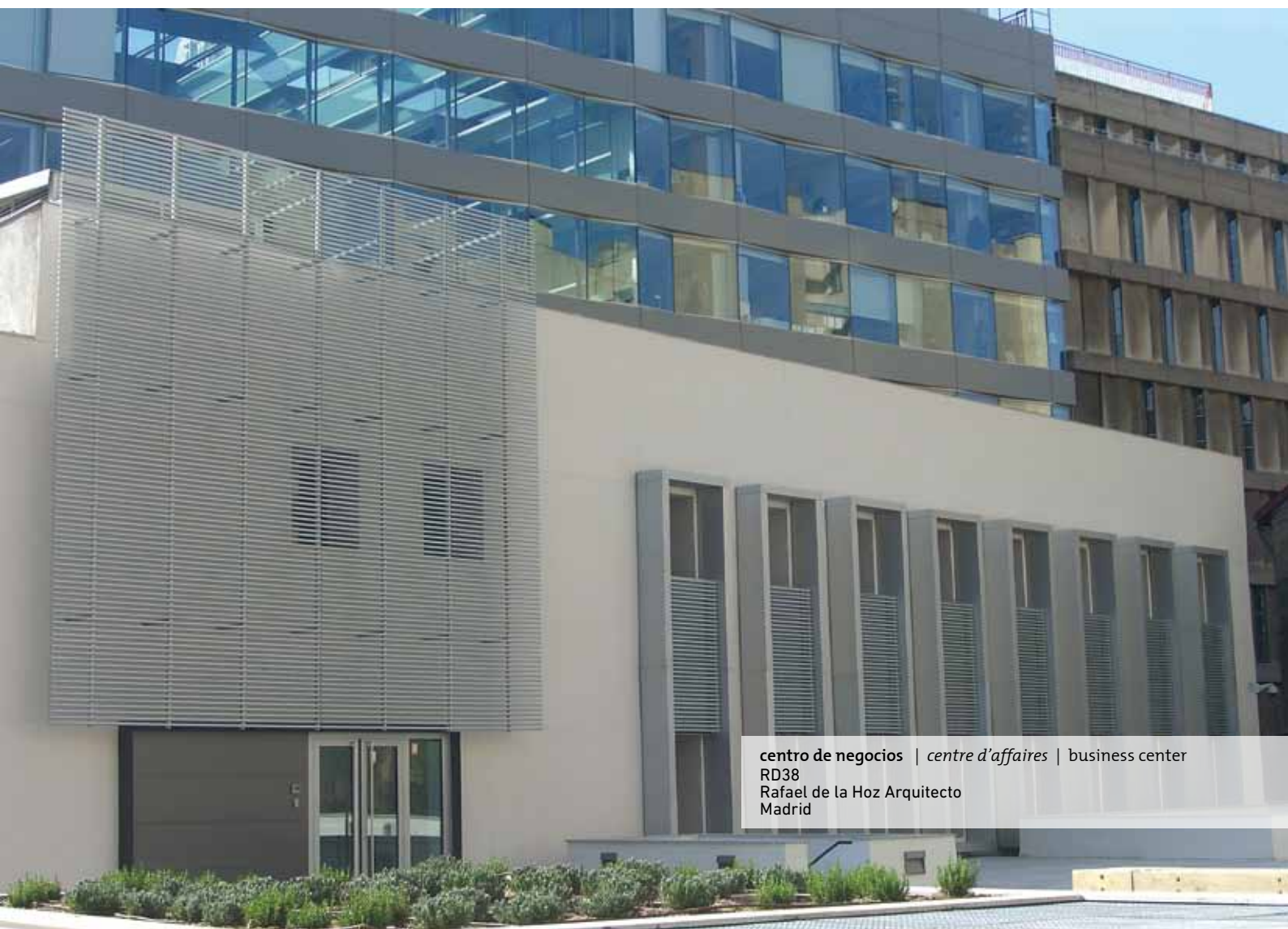

centro de negocios | *centre d'affaires* | business center
RD38
Rafael de la Hoz Arquitecto
Madrid

tamifix

aluminio | *aluminium* | aluminium

partesol continuo | *protection solaire filante* | continuous louver

lamas | *lames* | blades

RT18

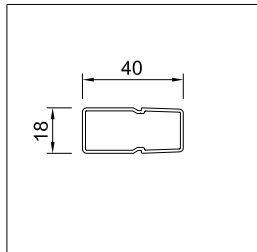

RD38

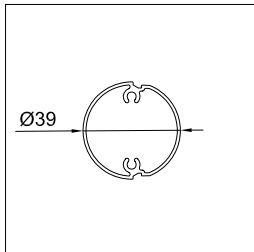

PT70

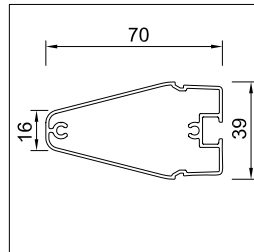

montantes | *montants* | mullions

M55.40

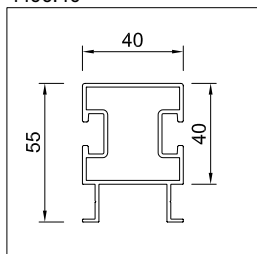

095.35

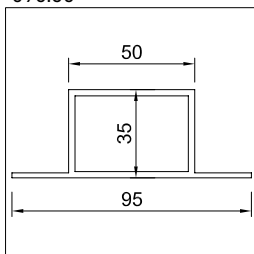

accesorios | *accessoires* | accessories

clip18

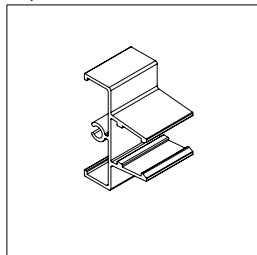

clip36

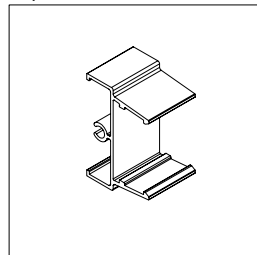

DIN7981.5.13

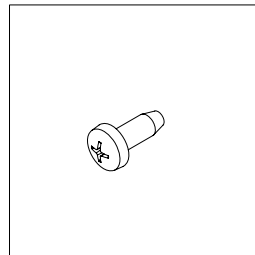

TM6

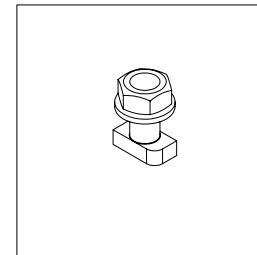

lama <i>lame</i> blade	montante <i>montant</i> mullion	fijación <i>fixation</i> fixation	posición lama <i>position lame</i> blade position		L max entre montantes <i>L max entre les montants</i> L max between mullions		P estandar <i>standard</i> standard	variable <i>variable</i> variable
			H	V	H	V		
RT18	M55.40	Clip18	✓	✓	1200 mm	1200 mm	50 mm	✓
RD38	M55.40	Clip36	✓	✓	1200 mm	1200 mm	75 mm	✓
PT70	M55.40	Clip36	✓	✓	1500 mm	1500 mm	75 mm	✓
PT70	095.35	TM6	✓	✓	2000 mm	2000 mm	75 mm	✓

tamifix

aluminio | aluminium | aluminium

partesol continuo | protection solaire filante | continuos louver

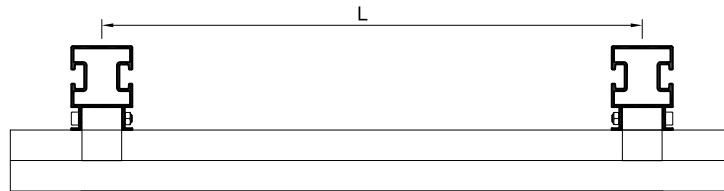
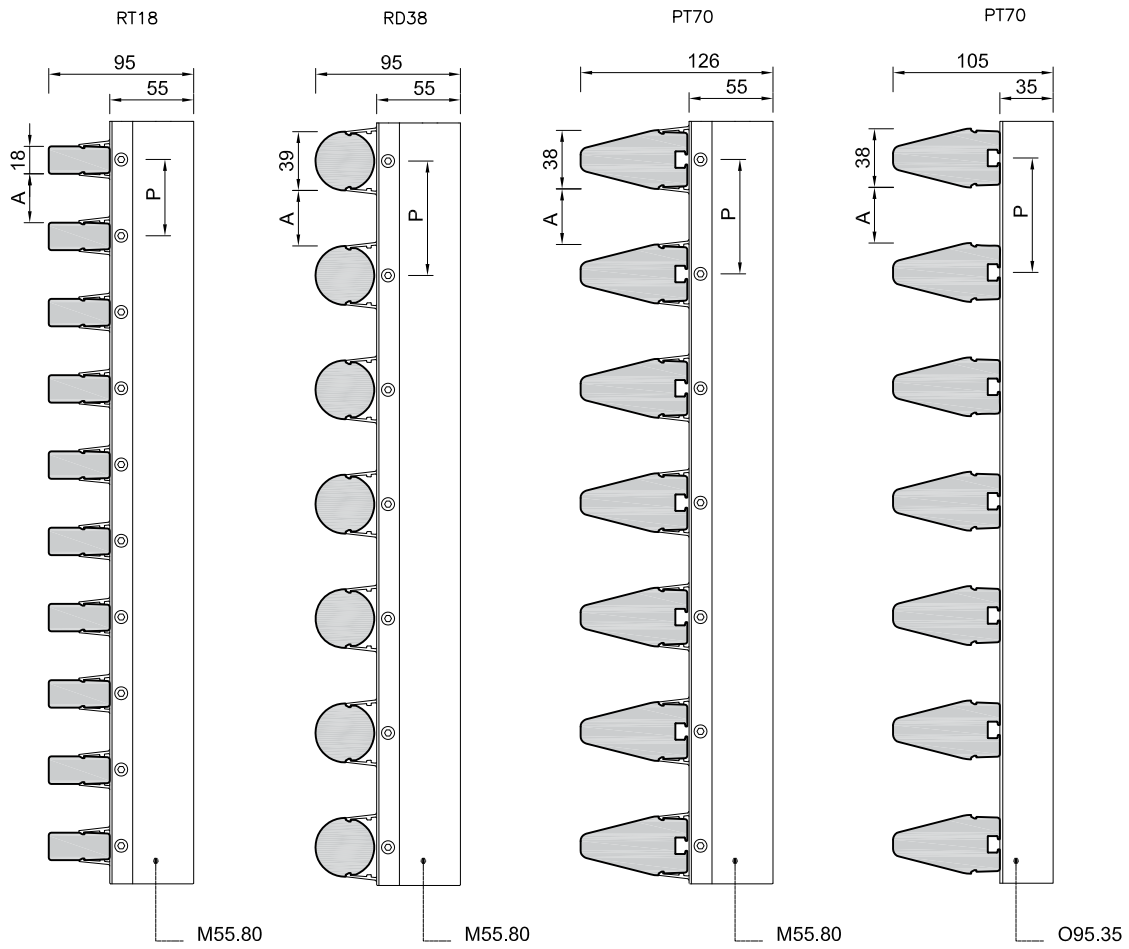

detalle ensamble clip
détail du montage clip
detail clip assembly

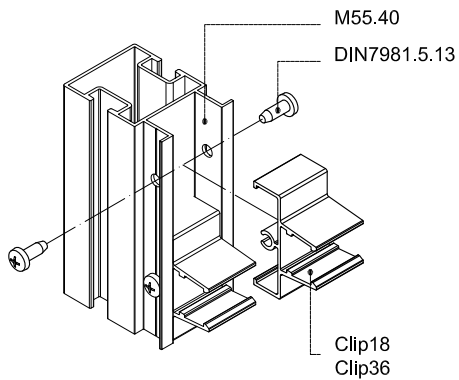

PT70
detalle fijación mecánica
détail avec vis de fixation
detail with fixing screw

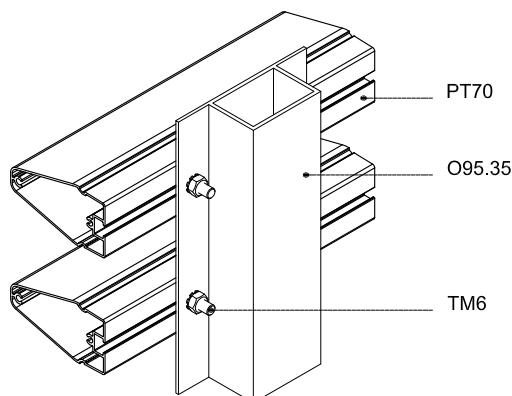

"EASY-CLICK"
fácil y seguro
facile et sûr
easy and safe

